

HYDRAULIC MAGNETS

HMG/T SERIES

6 MODELS HYDRAULIC MAGNETS FROM 780 UP TO 2.500 KGS FOR CARRIERS FROM 10 ~ 60 TONS

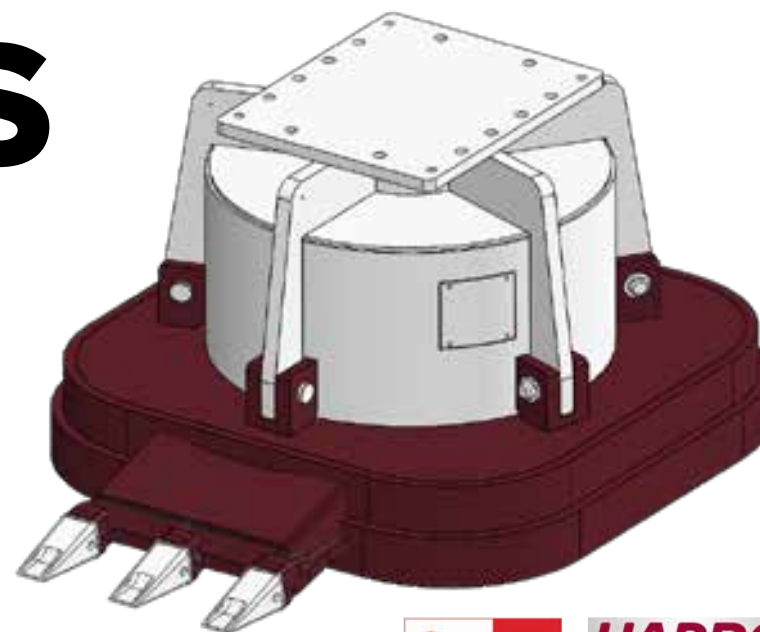







6 MODELS HYDRAULIC MAGNETS **WITH TEETH** FROM 950 UP TO 3.000 KGS FOR CARRIERS FROM 10 ~ 60 TONS



Without teeth		HMG-850	HMG-950	HMG-1100	HMG-1150	HMG-1300	HMG-1500
(1) Excavatorclass	T.	10 - 14	14 - 17	19 - 23	20 - 25	26 - 32	30 - 60
Weight	Kg.	780	960	1100	1200	1880	2500
Diameter	mm.	850	950	1050	1130	1250	1500
Workingpressure excavator	Bar	180	180	180	180	180	180
Oilflow	L/min.	38 - 200	50 - 200	70 - 200	80 - 200	100 - 200	100 - 200
Output	Kw.	3.5	4.5	5.5	6	7	12
Voltage	Volt.	230	230	230	230	230	230
Loose scrap	Kg.	250	350	450	650	900	1500
Massive plate	Kg.	3500	3500	7000	11000	12000	20000

(1) Recommended excavator / attachment combination

HMG-T Equipped with exchangeable teeth

With teeth		HMG-T850	HMG-T950	HMG-T1100	HMG-T1150	HMG-T1300	HMG-T1500
 (1) Excavatorclass	T.	10 - 14	14 - 17	19 - 23	20 - 25	26 - 32	34 - 60
 Weight	Kg.	950	1130	1315	1400	2100	3000
 Diameter	mm.	850	950	1050	1130	1250	1500
 Workingpressure excavator	Bar	180	180	180	180	180	180
 Oilflow	L/min.	38 - 200	50 - 200	70 - 200	80 - 200	100 - 200	100 - 200
 Output	Kw.	3.5	4.5	5.5	6	7	12
 Voltage	Volt.	230	230	230	230	230	230
 Loose scrap	Kg.	250	350	450	650	900	1500
 Massive plate	Kg.	3500	3500	7000	11000	12000	20000

